

DIGITAL DRUM BRAKE CALIPER

DATA
OUTPUT

2

3

calibration block (included)

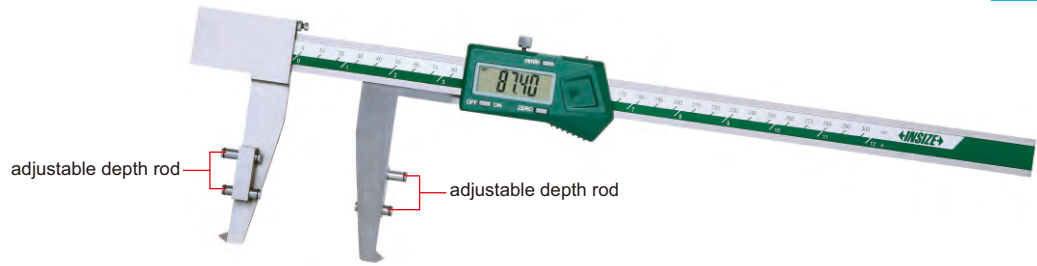

1538-300

- Measure internal diameter of drum brakes
- Resolution: 0.01mm/0.0005"
- Buttons: on/off, zero, mm/inch
- Automatic power off, move the digital unit to turn on power
- Battery CR2032
- Data output
- Made of stainless steel
- Optional accessory: data output cable (code 7315-22, 7302-22)

| Code | Range | Accuracy |
|----------|------------------|----------|
| 1538-300 | 30-300mm/1.2-12" | ±0.05mm |

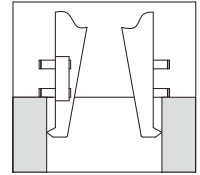
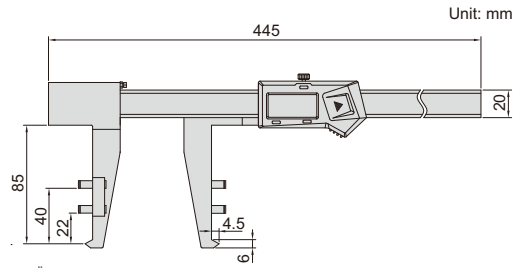

IP67 WATERPROOF DIGITAL DEPTH GAGES

IP67
WATERPROOF

ATTENTION: NO
DATA OUTPUT

- IP67 dust/waterproof
- Resolution: 0.01mm/0.0005"
- Button function: zero, on/off, mm/inch, ABS/REL, hold
- Meet DIN862
- Battery CR2032
- Made of stainless steel



1149-150

ATTENTION: IT IS NECESSARY TO SET
ZERO AFTER POWER ON EACH TIME

| Code | Range | Accuracy | L | a | b | d |
|----------|---------------|----------|-------|-----|------|-------|
| 1149-150 | 0-150mm/0-6" | ±0.03mm | 240mm | 6mm | 16mm | 100mm |
| 1149-200 | 0-200mm/0-8" | ±0.03mm | 290mm | 6mm | 16mm | 100mm |
| 1149-300 | 0-300mm/0-12" | ±0.03mm | 390mm | 6mm | 16mm | 150mm |

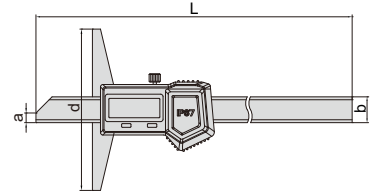

IP67 WATERPROOF DIGITAL DEPTH GAGES

ATTENTION: WHEN POWER ON 8 HOURS AFTER
SHUTDOWN, IT IS NECESSARY TO SET ZERO

ATTENTION:
NO DATA OUTPUT

IP67
WATERPROOF

- IP67 dust/waterproof
- Resolution: 0.01mm/0.0005"
- Large display
- Button function: zero, on/off, mm/inch
- Battery CR2032, automatic power off
- Meet DIN862
- Made of stainless steel



1541-150

| Code | Range | Accuracy | L | a | d |
|----------|---------------|----------|---------|--------|-------|
| 1541-150 | 0-150mm/0-6" | ±0.03mm | 232.5mm | 11mm | 100mm |
| 1541-200 | 0-200mm/0-8" | ±0.03mm | 285mm | 11mm | 100mm |
| 1541-300 | 0-300mm/0-12" | ±0.03mm | 390mm | 13.5mm | 150mm |

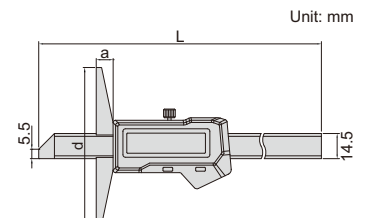

IP67
WATERPROOF

BLUETOOTH

BUILT-IN BLUETOOTH IP67 WATERPROOF DIGITAL DEPTH GAGES

ATTENTION: THE WORKING LIFE OF A BATTERY IS ABOUT 4-6 MONTHS

ATTENTION: WHEN POWER ON 8 HOURS AFTER SHUTDOWN, IT IS NECESSARY TO SET ZERO

- Built-in bluetooth 4.0 wireless transmission module, connect with computers (with bluetooth receiver), mobile phones, tablets, etc., and output keyboard signals
- Transmission distance is 10 meters (under the condition of no obstruction and no electromagnetic interference)
- IP67 dust/waterproof
- Resolution: 0.01mm/0.0005"
- Large display
- Button function: zero, on/off, mm/inch, data transmission
- Battery CR2032, automatic power off
- Meet DIN862
- Made of stainless steel



1542-150

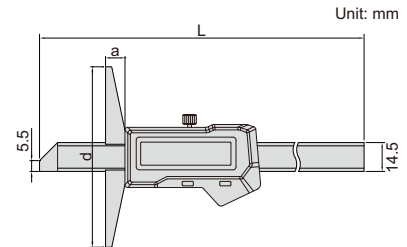

| Code | Range | Accuracy | L | a | d |
|----------|---------------|----------|---------|--------|-------|
| 1542-150 | 0-150mm/0-6" | ±0.03mm | 232.5mm | 11mm | 100mm |
| 1542-200 | 0-200mm/0-8" | ±0.03mm | 285mm | 11mm | 100mm |
| 1542-300 | 0-300mm/0-12" | ±0.03mm | 390mm | 13.5mm | 150mm |

DATA
OUTPUT

DIGITAL DEPTH GAGES (STANDARD TYPE)

- Buttons: on/off, zero, mm/inch
- Automatic power off, move the digital unit to turn on power
- Meet DIN862 (except 0-500mm/0-20", 0-1000mm/0-40", 0-1500mm/0-60")
- Battery CR2032
- Made of stainless steel



1141-150A

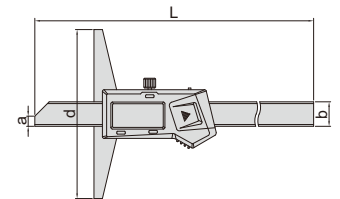

With data interface

| Code | Range | Resolution | Accuracy | L | a | b | d | Data output cable (optional) |
|-------------|----------------|----------------|----------|--------|-----|--------|-------|------------------------------|
| 1141-150A | 0-150mm/0-6" | 0.01mm/0.0005" | ±0.03mm | 230mm | 6mm | 14.5mm | 100mm | 7315-21, 7302-21 |
| 1141-200A | 0-200mm/0-8" | 0.01mm/0.0005" | ±0.03mm | 280mm | 6mm | 14.5mm | 100mm | 7315-21, 7302-21 |
| 1141-300A | 0-300mm/0-12" | 0.01mm/0.0005" | ±0.03mm | 380mm | 6mm | 14.5mm | 150mm | 7315-21, 7302-21 |
| 1141-500A | 0-500mm/0-20" | 0.01mm/0.0005" | ±0.05mm | 585mm | 7mm | 15mm | 150mm | 7315-22, 7302-22 |
| 1141-5001A | 0-500mm/0-20" | 0.01mm/0.0005" | ±0.05mm | 585mm | 7mm | 15mm | 200mm | 7315-22, 7302-22 |
| 1141-1000A | 0-1000mm/0-40" | 0.01mm/0.0005" | ±0.07mm | 1188mm | 7mm | 18mm | 150mm | 7315-22, 7302-22 |
| 1141-10001A | 0-1000mm/0-40" | 0.01mm/0.0005" | ±0.07mm | 1188mm | 7mm | 18mm | 200mm | 7315-22, 7302-22 |
| 1141-10002A | 0-1000mm/0-40" | 0.01mm/0.0005" | ±0.07mm | 1188mm | 7mm | 18mm | 250mm | 7315-22, 7302-22 |
| 1141-10003A | 0-1000mm/0-40" | 0.01mm/0.0005" | ±0.07mm | 1188mm | 7mm | 18mm | 300mm | 7315-22, 7302-22 |
| 1141-1500A | 0-1500mm/0-60" | 0.01mm/0.0005" | ±0.11mm | 1695mm | 7mm | 18mm | 200mm | 7315-22, 7302-22 |

Built-in wireless (receiver code 7315-2/3/6/7/8 is required)

| Code | Range | Resolution | Accuracy | L | a | b | d |
|--------------|---------------|----------------|----------|-------|-----|--------|-------|
| 1141-150AWL | 0-150mm/0-6" | 0.01mm/0.0005" | ±0.03mm | 230mm | 6mm | 14.5mm | 100mm |
| 1141-200AWL | 0-200mm/0-8" | 0.01mm/0.0005" | ±0.03mm | 280mm | 6mm | 14.5mm | 100mm |
| 1141-300AWL | 0-300mm/0-12" | 0.01mm/0.0005" | ±0.03mm | 380mm | 6mm | 14.5mm | 150mm |
| 1141-500AWL | 0-500mm/0-20" | 0.01mm/0.0005" | ±0.05mm | 585mm | 7mm | 15mm | 150mm |
| 1141-5001AWL | 0-500mm/0-20" | 0.01mm/0.0005" | ±0.05mm | 585mm | 7mm | 15mm | 200mm |

DIGITAL DEPTH GAGES WITH MOUNTING HOLES FOR EXTENSION BASE

DATA
OUTPUT

3



1147-300

- Resolution: 0.01mm/0.0005"
- Buttons: on/off, zero, mm/inch
- Automatic power off, move the digital unit to turn on power
- Meet DIN862
- Battery CR2032
- Made of stainless steel
- Optional accessory: extension base (code 6141)

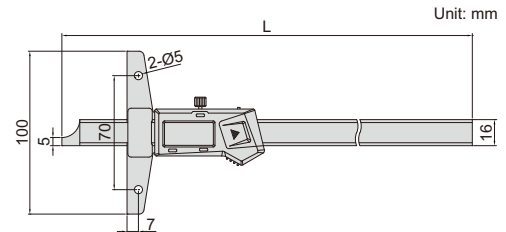
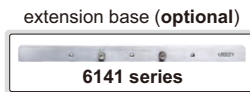

With data interface (data output cable code 7315-21, 7302-21, optional)

| Code | Range | Accuracy | L |
|----------|---------------|----------|-------|
| 1147-150 | 0-150mm/0-6" | ±0.03mm | 237mm |
| 1147-200 | 0-200mm/0-8" | ±0.03mm | 287mm |
| 1147-300 | 0-300mm/0-12" | ±0.03mm | 403mm |
| 1147-500 | 0-500mm/0-20" | ±0.05mm | 605mm |

Built-in wireless (receiver code 7315-2/3/6/7/8 is required)

| Code | Range | Accuracy | L |
|------------|---------------|----------|-------|
| 1147-150WL | 0-150mm/0-6" | ±0.03mm | 237mm |
| 1147-200WL | 0-200mm/0-8" | ±0.03mm | 287mm |
| 1147-300WL | 0-300mm/0-12" | ±0.03mm | 403mm |
| 1147-500WL | 0-500mm/0-20" | ±0.05mm | 605mm |

DIGITAL HOOK DEPTH GAGES

DATA
OUTPUT

- Resolution: 0.01mm/0.0005"
- Buttons: on/off, zero, mm/inch
- Automatic power off, move the digital unit to turn on power
- Battery CR2032
- Made of stainless steel

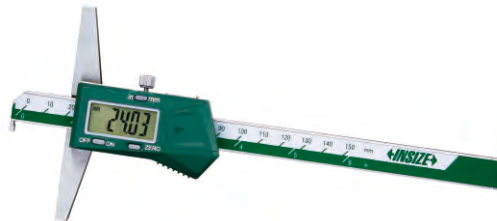

1142-150A

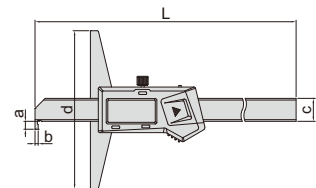

With data interface

| Code | Range | Accuracy | L | d | a | b | c | Data output cable (optional) |
|-------------|----------------|----------|--------|-------|------|-----|--------|------------------------------|
| 1142-150A | 0-150mm/0-6" | ±0.03mm | 230mm | 100mm | 5mm | 2mm | 14.5mm | 7315-21, 7302-21 |
| 1142-200A | 0-200mm/0-8" | ±0.03mm | 280mm | 100mm | 5mm | 2mm | 14.5mm | 7315-21, 7302-21 |
| 1142-300A | 0-300mm/0-12" | ±0.04mm | 380mm | 150mm | 5mm | 2mm | 14.5mm | 7315-21, 7302-21 |
| 1142-500A | 0-500mm/0-20" | ±0.05mm | 585mm | 150mm | 8mm | 3mm | 15mm | 7315-22, 7302-22 |
| 1142-5001A | 0-500mm/0-20" | ±0.05mm | 585mm | 200mm | 8mm | 3mm | 15mm | 7315-22, 7302-22 |
| 1142-1000A | 0-1000mm/0-40" | ±0.07mm | 1188mm | 150mm | 10mm | 4mm | 18mm | 7315-22, 7302-22 |
| 1142-10001A | 0-1000mm/0-40" | ±0.07mm | 1188mm | 200mm | 10mm | 4mm | 18mm | 7315-22, 7302-22 |
| 1142-10002A | 0-1000mm/0-40" | ±0.07mm | 1188mm | 250mm | 10mm | 4mm | 18mm | 7315-22, 7302-22 |

Built-in wireless (receiver code 7315-2/3/6/7/8 is required)

| Code | Range | Accuracy | L | d | a | b | c |
|--------------|---------------|----------|-------|-------|-----|-----|--------|
| 1142-150AWL | 0-150mm/0-6" | ±0.03mm | 230mm | 100mm | 5mm | 2mm | 14.5mm |
| 1142-200AWL | 0-200mm/0-8" | ±0.03mm | 280mm | 100mm | 5mm | 2mm | 14.5mm |
| 1142-300AWL | 0-300mm/0-12" | ±0.04mm | 380mm | 150mm | 5mm | 2mm | 14.5mm |
| 1142-500AWL | 0-500mm/0-20" | ±0.05mm | 585mm | 150mm | 8mm | 3mm | 15mm |
| 1142-5001AWL | 0-500mm/0-20" | ±0.05mm | 585mm | 200mm | 8mm | 3mm | 15mm |

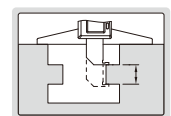
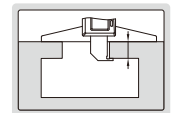
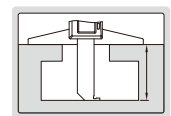

DATA
OUTPUT

DIGITAL DOUBLE HOOK DEPTH GAGES

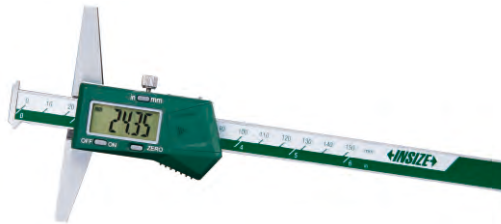

1144-150A

- Resolution: 0.01mm/0.0005"
- Buttons: on/off, zero, mm/inch
- Automatic power off, move the digital unit to turn on power
- Meet DIN862
- Battery CR2032
- Made of stainless steel

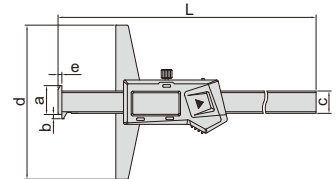
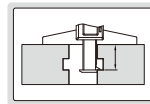
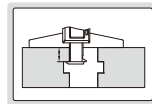

With data interface

| Code | Range | Accuracy | L | d | a | b | c | e | Data output cable (optional) |
|-------------|----------------|----------|--------|-------|--------|-------|--------|-------|------------------------------|
| 1144-150A | 0-150mm/0-6" | ±0.03mm | 233mm | 100mm | 21.5mm | 3.5mm | 14.5mm | 2.5mm | 7315-21, 7302-21 |
| 1144-200A | 0-200mm/0-8" | ±0.03mm | 283mm | 100mm | 21.5mm | 3.5mm | 14.5mm | 2.5mm | 7315-21, 7302-21 |
| 1144-300A | 0-300mm/0-12" | ±0.03mm | 383mm | 150mm | 21.5mm | 3.5mm | 14.5mm | 2.5mm | 7315-21, 7302-21 |
| 1144-500A | 0-500mm/0-20" | ±0.05mm | 585mm | 150mm | 25mm | 5mm | 15mm | 3mm | 7315-22, 7302-22 |
| 1144-5001A | 0-500mm/0-20" | ±0.05mm | 585mm | 200mm | 25mm | 5mm | 15mm | 3mm | 7315-22, 7302-22 |
| 1144-1000A | 0-1000mm/0-40" | ±0.07mm | 1188mm | 150mm | 32mm | 7mm | 18mm | 4mm | 7315-22, 7302-22 |
| 1144-10001A | 0-1000mm/0-40" | ±0.07mm | 1188mm | 200mm | 32mm | 7mm | 18mm | 4mm | 7315-22, 7302-22 |
| 1144-10002A | 0-1000mm/0-40" | ±0.07mm | 1188mm | 250mm | 32mm | 7mm | 18mm | 4mm | 7315-22, 7302-22 |

Built-in wireless (receiver code 7315-2/3/6/7/8 is required)

| Code | Range | Accuracy | L | d | a | b | c | e |
|--------------|---------------|----------|-------|-------|--------|-------|--------|-------|
| 1144-150AWL | 0-150mm/0-6" | ±0.03mm | 233mm | 100mm | 21.5mm | 3.5mm | 14.5mm | 2.5mm |
| 1144-200AWL | 0-200mm/0-8" | ±0.03mm | 283mm | 100mm | 21.5mm | 3.5mm | 14.5mm | 2.5mm |
| 1144-300AWL | 0-300mm/0-12" | ±0.03mm | 383mm | 150mm | 21.5mm | 3.5mm | 14.5mm | 2.5mm |
| 1144-500AWL | 0-500mm/0-20" | ±0.05mm | 585mm | 150mm | 25mm | 5mm | 15mm | 3mm |
| 1144-5001AWL | 0-500mm/0-20" | ±0.05mm | 585mm | 200mm | 25mm | 5mm | 15mm | 3mm |

 DATA
OUTPUT

DIGITAL POINT DEPTH GAGES

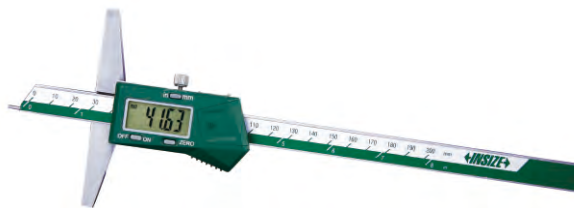

1143-200A

- Resolution: 0.01mm/0.0005"
- Buttons: on/off, zero, mm/inch
- Automatic power off, move the digital unit to turn on power
- Meet DIN862
- Battery CR2032
- Made of stainless steel

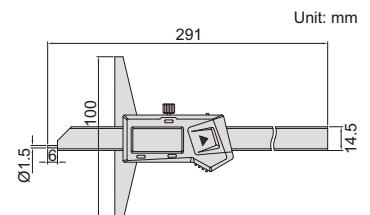
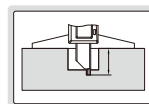

With data interface (data output cable code 7315-21, 7302-21, optional)

| Code | Range | Accuracy |
|-----------|--------------|----------|
| 1143-200A | 0-200mm/0-8" | ±0.03mm |

Built-in wireless (receiver code 7315-2/3/6/7/8 is required)

| Code | Range | Accuracy |
|-------------|--------------|----------|
| 1143-200AWL | 0-200mm/0-8" | ±0.03mm |

DIGITAL DEPTH GAGES WITH ROUND DEPTH BAR

MEASURE WIDTH AND DEPTH OF GROOVES INSIDE BORE

MEASURE DEPTH OF SMALL HOLES (>Ø4mm)

DATA OUTPUT

3

- Resolution: 0.01mm/0.0005"
- Supplied with three interchangeable points (flat, spherical, disk)
- Buttons: on/off, set, mm/inch, preset (+, -)
- Automatic power off, move the digital unit to turn on power
- Battery CR2032
- Made of stainless steel
- Optional accessory: extension base (code 6141, for 1148-120, 1148-120WL, 1148-200, 1148-200WL, 1148-300 and 1148-300WL)

preset buttons



1148-100S



1148-120

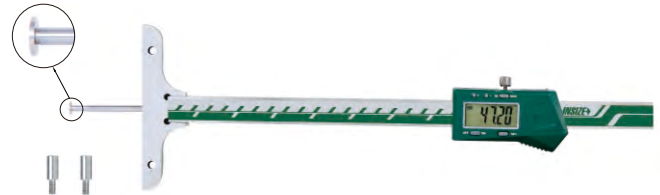

1148-200

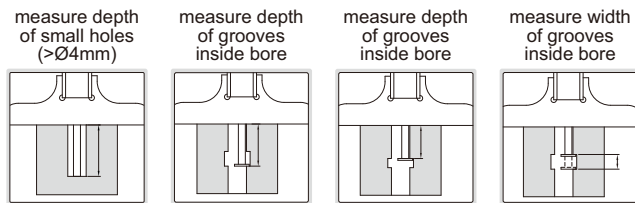
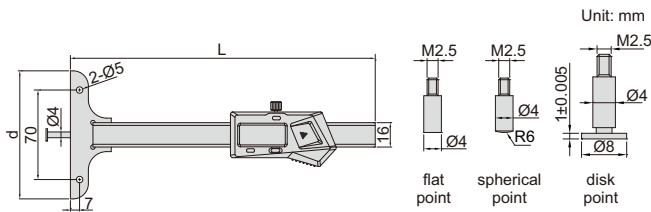

With data interface (data output cable code 7315-21, 7302-21, optional)

| Code | Range * | Accuracy | L | d | Remark |
|-----------|----------------|----------|-------|-------|--|
| 1148-100S | 0-100mm/0-4" | ±0.02mm | 200mm | 45mm | |
| 1148-100 | 0-100mm/0-4" | ±0.02mm | 200mm | 85mm | |
| 1148-120 | 0-120mm/0-4.7" | ±0.03mm | 300mm | 101mm | one-hand use, with mounting holes for extension base |
| 1148-200 | 0-200mm/0-8" | ±0.03mm | 300mm | 101mm | with mounting holes for extension base |
| 1148-300 | 0-300mm/0-12" | ±0.04mm | 400mm | 101mm | with mounting holes for extension base |

one-hand use of 1148-120 and 1148-120WL



extension base for 1148-120, 1148-120WL, 1148-200, 1148-200WL, 1148-300 and 1148-300WL (optional)



Built-in wireless (receiver code 7315-2/3/6/7/8 is required)

| Code | Range * | Accuracy | L | d | Remark |
|-------------|----------------|----------|-------|-------|--|
| 1148-100SWL | 0-100mm/0-4" | ±0.02mm | 200mm | 45mm | |
| 1148-100WL | 0-100mm/0-4" | ±0.02mm | 200mm | 85mm | |
| 1148-120WL | 0-120mm/0-4.7" | ±0.03mm | 300mm | 101mm | one-hand use, with mounting holes for extension base |
| 1148-200WL | 0-200mm/0-8" | ±0.03mm | 300mm | 101mm | with mounting holes for extension base |
| 1148-300WL | 0-300mm/0-12" | ±0.04mm | 400mm | 101mm | with mounting holes for extension base |

1148-P103 (optional), measure width of bottom grooves inside blind hole

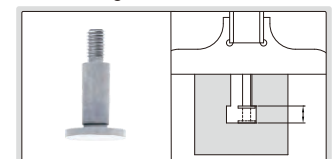

*When disk points are used, the range is reduced by 10mm

OPTIONAL DISK POINTS

| Code | Description | H | Remark |
|-----------|------------------|-------------|-------------------------------|
| 1148-P101 | 0.5mm disk point | 0.5±0.005mm | for narrow grooves |
| 1148-P102 | 0.7mm disk point | 0.7±0.005mm | for narrow grooves |
| 1148-P103 | 1mm disk point | 1±0.005mm | for grooves inside blind hole |
| 1148-P104 | 0.5mm disk point | 0.5±0.005mm | for grooves inside blind hole |

1148-P101 (optional)

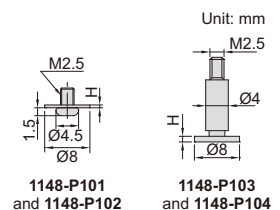

1148-P101 and 1148-P102

1148-P103 and 1148-P104

DATA OUTPUT

- Resolution: 0.01mm/0.0005"
- Buttons: on/off, zero, mm/inch, ABS/INC, data hold, TOL, set
- ABS/INC is for absolute and incremental measurement
- TOL is for tolerance measurement
- Made of stainless steel
- LR44 battery, data output
- Supplied with gage block for zero setting
- Optional accessory: extension base, wireless transmitter (code **7315-1150**), data output cable (code **7302-SPC7**, keyboard format)

DIGITAL DOUBLE HOOK DEPTH GAGE

Extension base

| Code | L |
|-----------|-------|
| 1540-L300 | 300mm |
| 1540-L400 | 400mm |
| 1540-L500 | 500mm |
| 1540-L600 | 600mm |
| 1540-L800 | 800mm |

gage block for zero setting (included)



| Code | Range | Accuracy |
|----------|---------------|----------|
| 1540-300 | 0-300mm/0-12" | ±0.04mm |

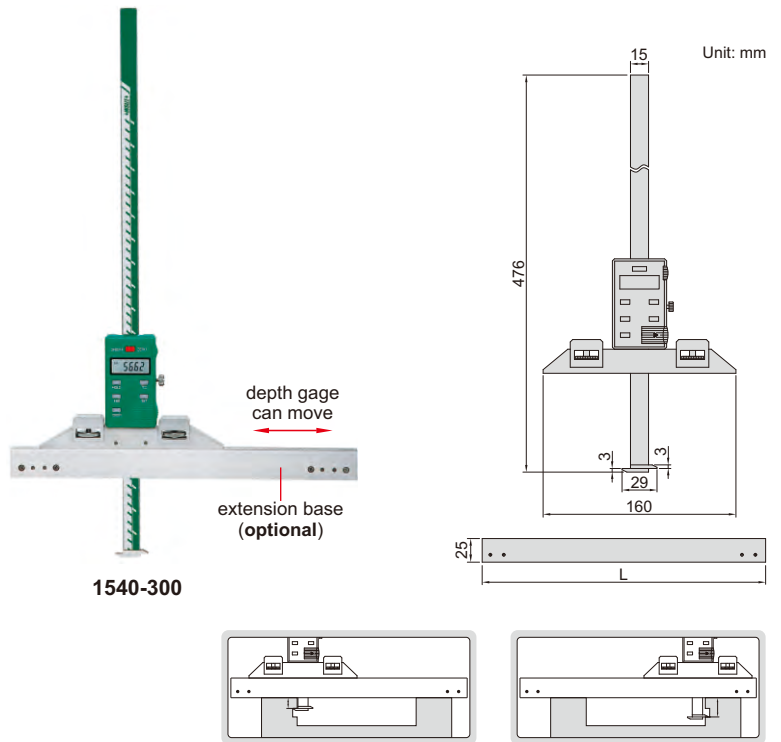

SHOCK PROOF

- Shockproof dial indicator
- Made of stainless steel

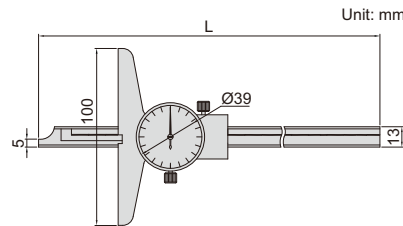

DIAL DEPTH GAGES



1340-150

| Code | Range | Graduation | Accuracy | L |
|----------|---------|------------|----------|-------|
| 1340-150 | 0-150mm | 0.02mm | ±0.03mm | 232mm |
| 1340-200 | 0-200mm | 0.02mm | ±0.03mm | 282mm |
| 1340-300 | 0-300mm | 0.02mm | ±0.04mm | 382mm |

VERNIER DEPTH GAGES (STANDARD TYPE)

- Made of stainless steel
- Satin chrome plated reading surface

Graduation 0.05mm

| Code | Range | Accuracy | L | d |
|----------|---------|----------|-------|-------|
| 1240-150 | 0-150mm | ±0.05mm | 245mm | 100mm |
| 1240-200 | 0-200mm | ±0.05mm | 282mm | 100mm |
| 1240-300 | 0-300mm | ±0.08mm | 382mm | 100mm |
| 1240-500 | 0-500mm | ±0.09mm | 585mm | 150mm |



1240-2001

Graduation 0.02mm

| Code | Range | Accuracy | L | d |
|-----------|---------|----------|-------|-------|
| 1240-1501 | 0-150mm | ±0.03mm | 245mm | 100mm |
| 1240-2001 | 0-200mm | ±0.03mm | 282mm | 100mm |
| 1240-3001 | 0-300mm | ±0.04mm | 382mm | 100mm |
| 1240-5001 | 0-500mm | ±0.05mm | 585mm | 150mm |

